

P1 Relay V23026

- Directly triggerable with TTL standard modules as ALS, HCT & ACT
- Slim line 13.5x7.85mm (0.531x0.309")
- Switching current 1 A
- Bifurcated 1 form C (CO) contact
- Immersion cleanable
- High sensitivity results in low nominal power consumption, 65 to 130mW for monostable and 30 to 150mW for bistable (latching)
- Initial surge withstand voltage
2.5kV (2/10µs) meets the Bellcore Requirement GR-1089
1.5kV (10/160µs) meets FCC Part 68

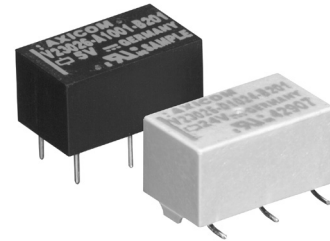

P1_THTSMD



Typical applications

Automotive equipment, CAN bus, immobilizer, office equipment, measurement and control equipment, medical equipment, safety equipment

Approvals

UL 508 File No. E 111441
Technical data of approved types on request

Contact Data

Contact arrangement	1 form C (CO)
Max. switching voltage	125VDC, 150VAC
Rated current	1A
Limiting continuous current, 85°C	1A
Breaking capacity max.	see max. DC load breaking capacity
Contact material	Palladium nickel, gold-rhodium covered bifurcated contact
Contact style	bifurcated contact
Min. recommended contact load	10mA at 20mV
Initial contact resistance	≤50mΩ at 10mA/20mV
Frequency of operation without load	200 ops./s
Operate/release time max.	2ms
Set/reset time max.	2ms
Bounce time max.	3ms
Electrical endurance	
at 12V/10mA	typ. 50x10 ⁶ operations
at 6V/100mA	typ. 10x10 ⁶ operations
at 30V/1000mA	typ. 10x10 ³ operations
Contact ratings	
UL contact ratings	30VDC/1A 65VDC/0.46A 150VAC/0.46A
Mechanical endurance	typ. 10 ⁹ operations

Max. DC load breaking capacity

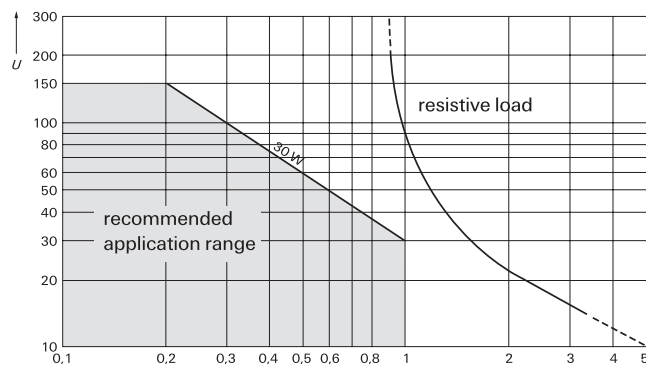

Coil Data

Magnetic system	polarized
Coil voltage range	3 to 24VDC other coil voltages on request
Operative range, IEC 61810	see coil operative range
Max. coil temperature	85°C
Thermal resistance	<130K/W

Coil versions, THT, monostable

Coil code	Rated voltage VDC	Operate voltage VDC	Release voltage VDC	Coil resistance Ω ±10%	Rated coil power mW
006	3	2.25	0.3	137	66
001	5	3.75	0.5	370	68
005	9	6.75	0.9	1165	70
002	12	9.00	1.2	2250	34
004	24	18.00	2.4	4500	128

All figures are given for coil without pre-energization, at ambient temperature +23°C.

Coil versions, SMT, monostable

Coil code	Rated voltage VDC	Operate voltage VDC	Release voltage VDC	Coil resistance Ω ±10%	Rated coil power mW
026	3	2.25	0.3	113	80
021	5	3.75	0.5	313	80
025	9	6.75	0.9	1015	80
022	12	9.00	1.2	1800	80
024	24	18.00	2.4	4500	128

All figures are given for coil without pre-energization, at ambient temperature +23°C.

Coil operative range, monostable DC coil

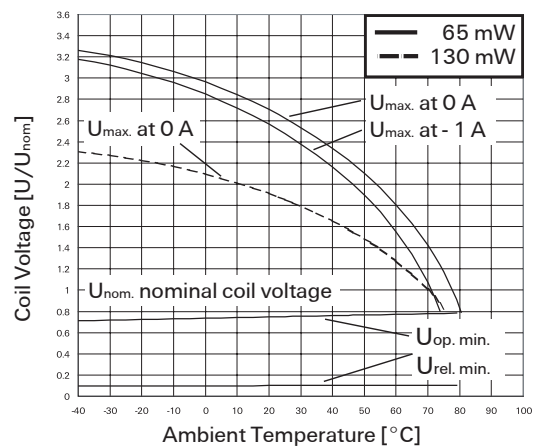

P1 Relay V23026 (Continued)

Coil data (continued)

Coil versions, THT and SMT, bistable 2 coils

Coil code	Rated voltage VDC	Set voltage VDC	Reset voltage VDC	Coil resistance $\Omega \pm 10\%$	Rated coil power mW
106	3	2.25	2.25	130	69
101	5	3.75	3.75	390	64
105	9	6.75	6.75	1200	68
102	12	9.00	9.00	1500	96

All figures are given for coil without pre-energization, at ambient temperature +23°C. Coils I and II are identical.

¹⁾ A nominal voltage of 24VDC is feasible with a 12VDC coil with a series resistor (1500 Ω).

Coil operative range, bistable

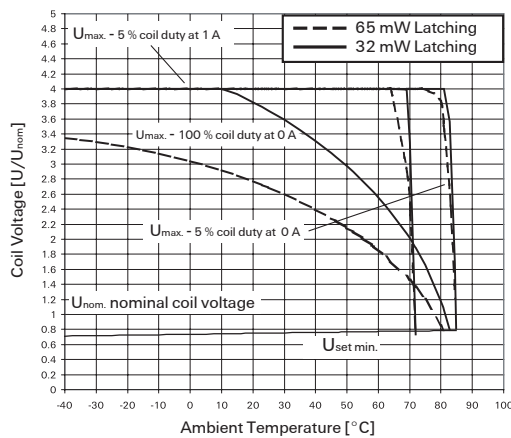

U_{max} upper limit of the operative range of the coil voltage (limiting voltage) when coils are continuously energized.

U_{op_min} lower limit of the operative range of the coil voltage (reliable operate voltage).

U_{rel_min} lower limit of the operative range of the coil voltage (reliable release voltage).

Dimensions

THT version

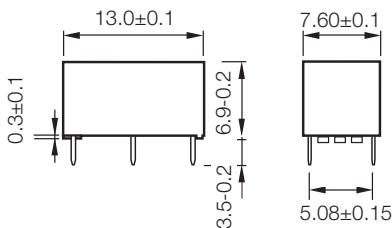

PCB layout

TOP view on component side of PCB

THT version

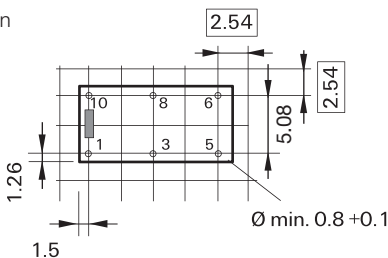

Insulation Data

Initial dielectric strength	
between open contacts	500V _{rms}
between contact and coil	1500V _{rms}
Initial surge withstand voltage	
between contact and coil	2500V
Capacitance	
between open contacts	max. 5pF
between contact and coil	max. 6pF
Clearance/creepage	
between contact and coil	0.75mm
between adjacent contacts	0.75mm

RF Data

Isolation at 100MHz/900MHz	-30.0dB/-18.0dB
Insertion loss at 100MHz/900MHz	-0.12dB/-1.9dB
Voltage standing wave ratio (VSWR) at 100MHz/900MHz	1.06/1.75

Other Data

Material compliance: EU RoHS/ELV, China RoHS, REACH, Halogen content refer to the Product Compliance Support Center at www.tycoelectronics.com/customer-support/rohssupportcenter

Ambient temperature	-40 to +85°C
Category of environmental protection, IEC 61810	RT III - immersion cleanable
Vibration resistance (functional)	20g, 200 to 2000Hz 40g, 10 to 200Hz
Shock resistance (functional) IEC 60068-2-27 (half sine)	50 g
Terminal type	PCB terminals and SMT terminals
Weight	max. 2g
Resistance to soldering heat THT IEC 60068-2-20	265 °C/10s
Resistance to soldering heat SMT IEC 60068-2-58	see reflow profile
Moisture sensitive level, JEDEC J-Std-020D	MSL3
Washing	not recommended
Ultrasonic cleaning	possible
Packaging unit	
THT	2000 pcs.
SMT	2400 pcs.

SMT version

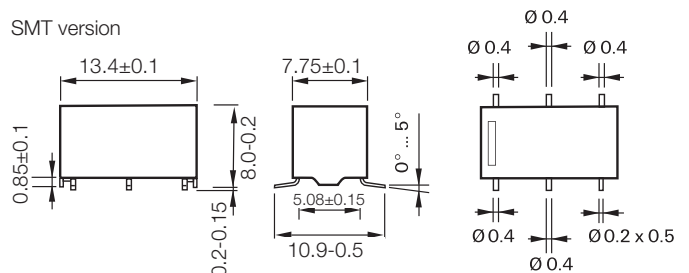

SMT version

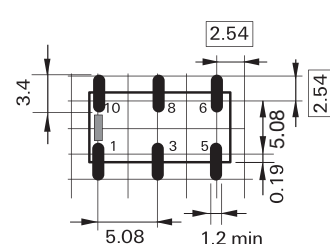

P1 Relay V23026 (Continued)

Terminal assignment

Monostable version
rest condition

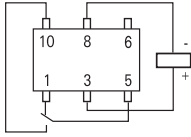

Bistable version, 1 coil
reset condition

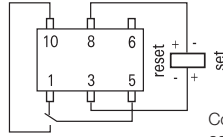

Bistable version, 2 coils
reset condition

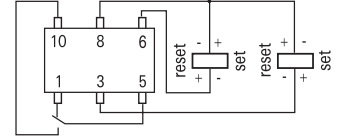

Contacts are shown in reset condition. Both coils can be used either as set or reset coil. Contact position might change during transportation and must be reset before use.

Processing

Recommended soldering conditions

Soldering conditions according IEC 60058-2-58 and IPC/JEDEC J-STD-020B

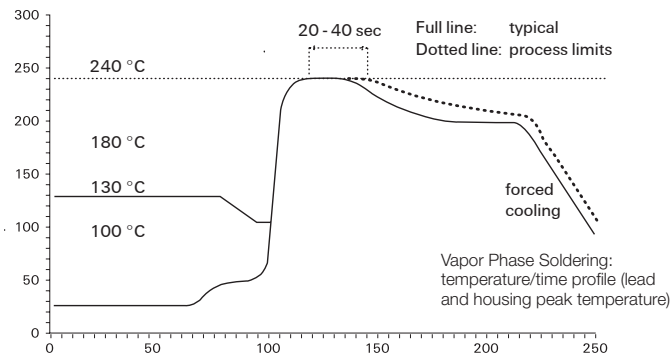

Packing

Tube for THT version
40 relays per tube, 2000 relays per box

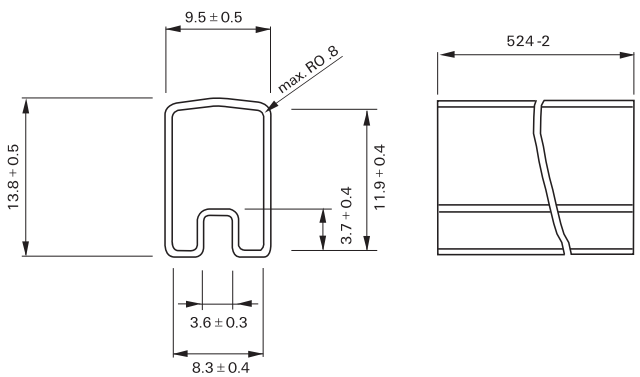

Resistance to soldering heat - Reflow profile

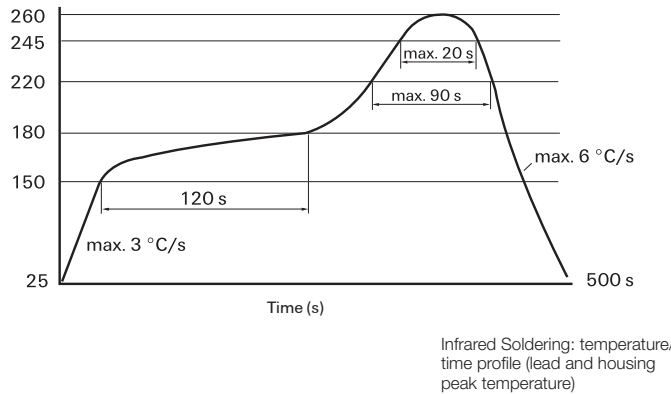

Tape and reel for SMT version
480 relays per reel, 2400 relays per box

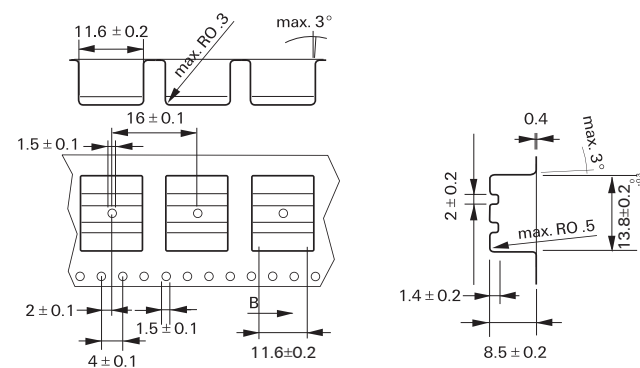

Recommended reflow soldering profile

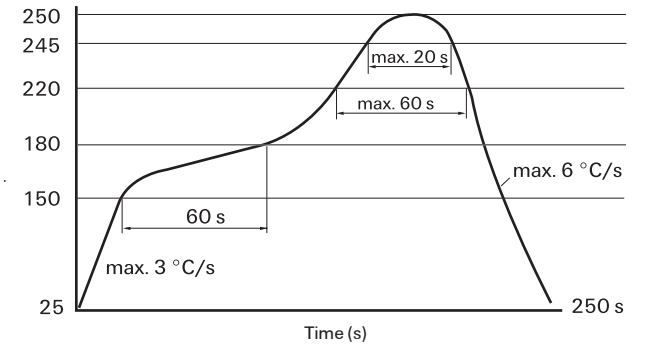

Reel dimensions

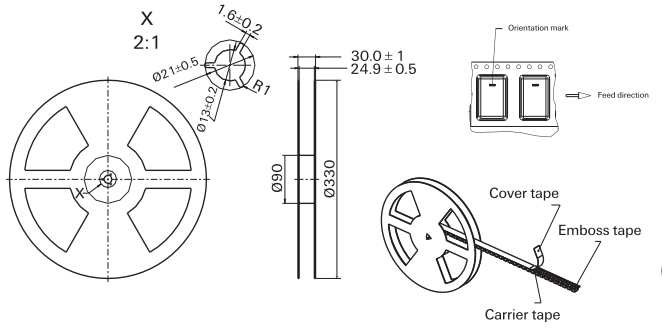

P1 Relay V23026 (Continued)

Product code structure		Typical product code	V23026	A1	002	B201
Type						
V23026 P1 Series Signal Relay						
Version						
A1 THT, monostable		D1 SMT, monostable				
B1 THT, bistable (latching), 2 coils		E1 SMT, bistable (latching), 2 coils				
C1 THT, bistable (latching), 1 coil		F1 SMT, bistable (latching), 1 coil				
Coil						
Coil code: please refer to coil versions table						
Contacts						
B201 1 form C, 1 CO						

Product Code	Version	Coil	Coil voltage	Part Number
V23026A1006B201	THT version	monostable	3VDC	1-1393774-7
V23026A1001B201			5VDC	1393774-1
V23026A1005B201			9VDC	1-1393774-5
V23026A1002B201			12VDC	1393774-8
V23026A1004B201			24VDC	1-1393774-2
V23026B1106B201			bistable, 2 coils	3VDC
V23026B1101B201		5VDC		3-1393774-4
V23026B1105B201		9VDC		1393775-2
V23026B1102B201		12VDC		3-1393774-5
V23026C1056B201		3VDC		2-1393774-6
V23026C1051B201		5VDC		2-1393774-0
V23026C1057B201		9VDC		2-1393774-7
V23026C1052B201		12VDC		2-1393774-1
V23026C1054B201		24VDC	2-1393774-4	
V23026D1026B201	SMT version	monostable	3VDC	1393776-8
V23026D1021B201			5VDC	1393776-3
V23026D1025B201			9VDC	1422015-9
V23026D1022B201			12VDC	1393776-4
V23026D1024B201			24VDC	1393776-7
V23026E1106B201			bistable, 2 coils	3VDC
V23026E1101B201		5VDC		1422015-6
V23026E1105B201		9VDC		1393777-2
V23026E1102B201		12VDC		1393776-9
V23026F1051B201				9VDC
V23026F1052B201	12VDC			4-1393774-3